



HYDRAULICKÉ SCHÉMY
ZAPOJENÍ KOTLOV NA BIOMASU
ATTACK®



*Variety zapojenia
kotlov na biomasu:*

ATTACK® WOOD&PELLET

ATTACK® PELLET

ATTACK® SLX

ATTACK® DPX

ATTACK® DP

ATTACK® FD Automat



WWW.ATTACK.SK

LEGENDA



Kotel rady:
DP
DPX
SLX
PELLET
WOOD & PELLET



Kotel rady:
FDA



Kotel rady:
PELLET



Automatický kotel



Akumulačná nádrž AK



Akumulačná nádrž AS



Akumulačná nádrž HR



Akumulačná nádrž HRS

OBSAH

LEGENDA	2 – 3
ATTACK-OVENTROP, ATTACK-LADDOMAT	4
ATTACK AK	5 – 7
ATTACK AS	8
ATTACK AK BIVALENT	9
ATTACK AK 2x	10
ATTACK HR	11

LEGENDA



Akumulačná nádrž TUV

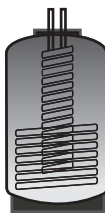

Akumulačná nádrž TUVS



Nádrž na TUV



Bivalentná nádrž na TUV

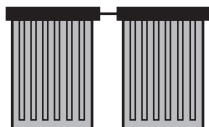

Solárne panely



Expanzná nádrž

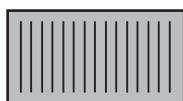

Radiátorový vykurovací okruh

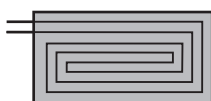

Podlahový vykurovací okruh



Anuloid

ATTACK HRS	12
ATTACK HRS + ATTACK AK	13
ATTACK TUV	14
ATTACK TUVS	15
ATTACK FD Automat + ATTACK AK	16
ATTACK FD Automat + ATTACK AS	17
ATTACK FD Automat	18 – 20
ATTACK PELLET 30 AUTOMATIC Plus	21 – 23

ATTACK-OVENTROP

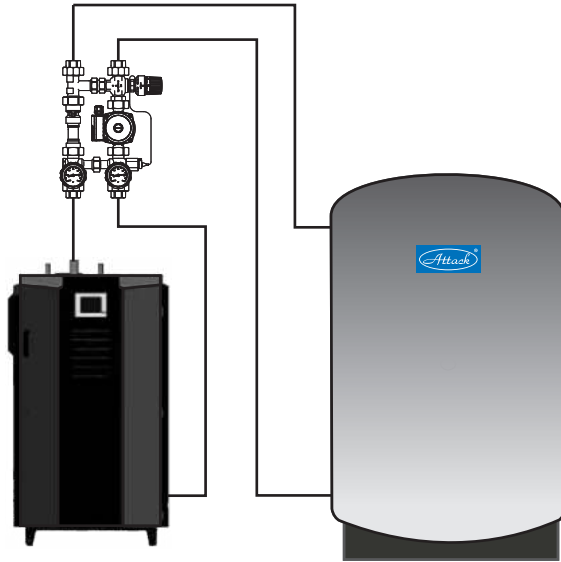

ATTACK-LADDOMAT

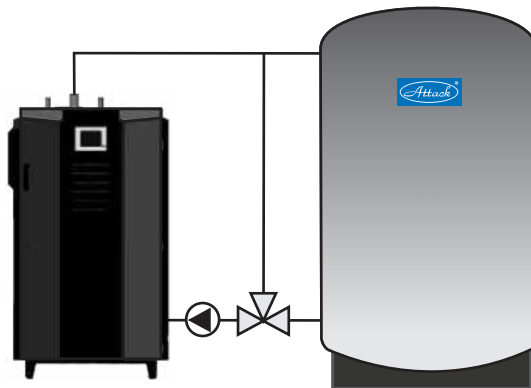

1. ATTACK AK

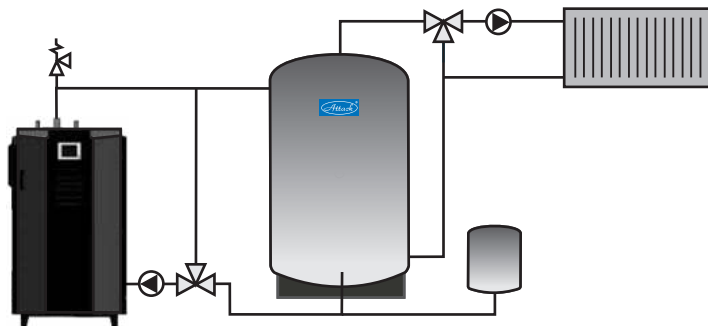

2. ATTACK AK

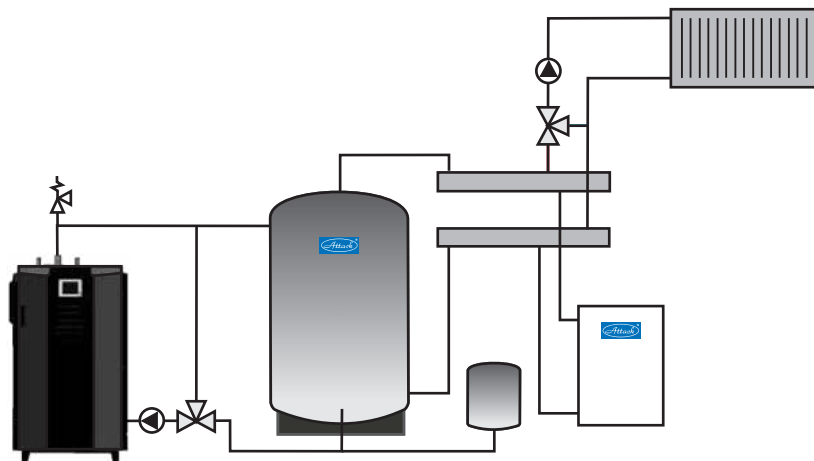

3. ATTACK AK

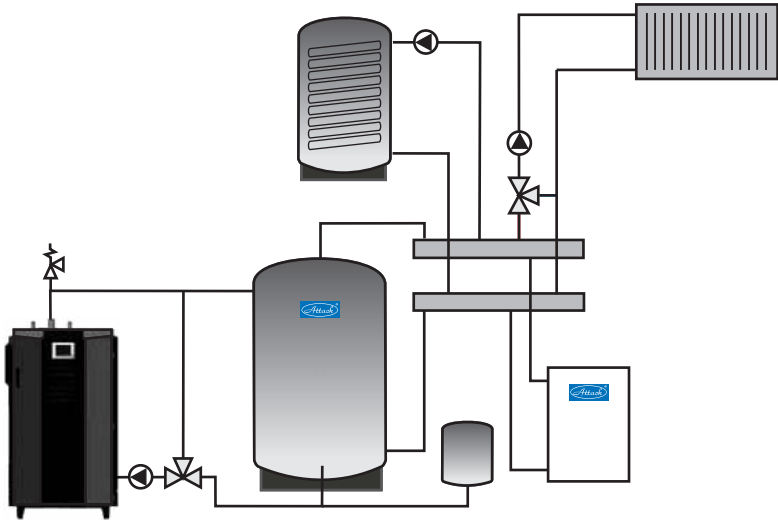

4. ATTACK AK

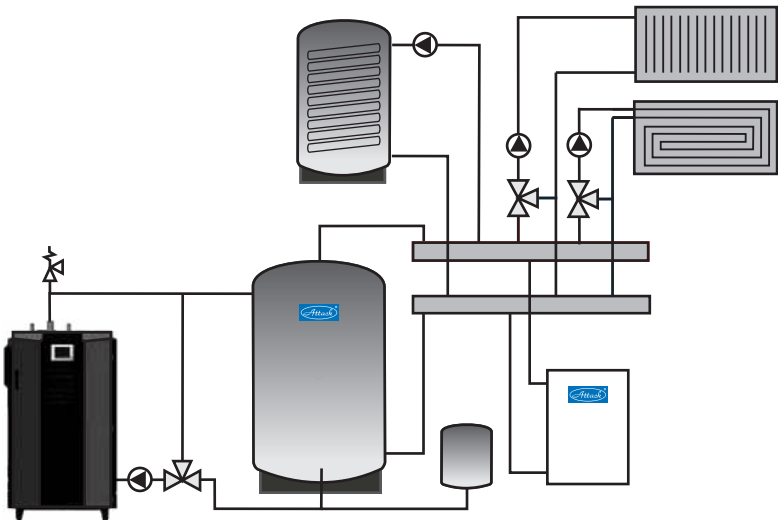

5. ATTACK AK

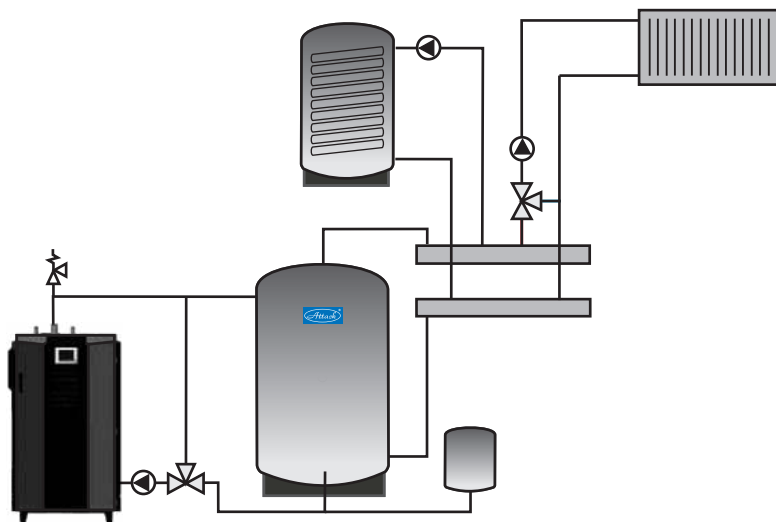

6. ATTACK AK

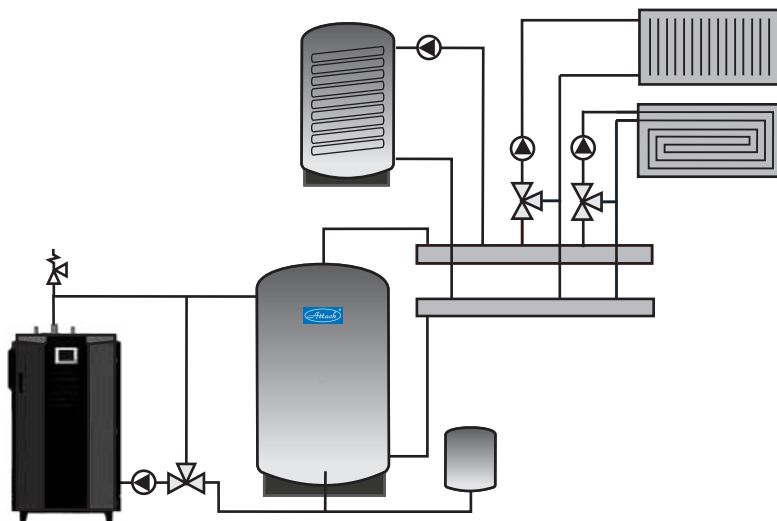

7. ATTACK AS

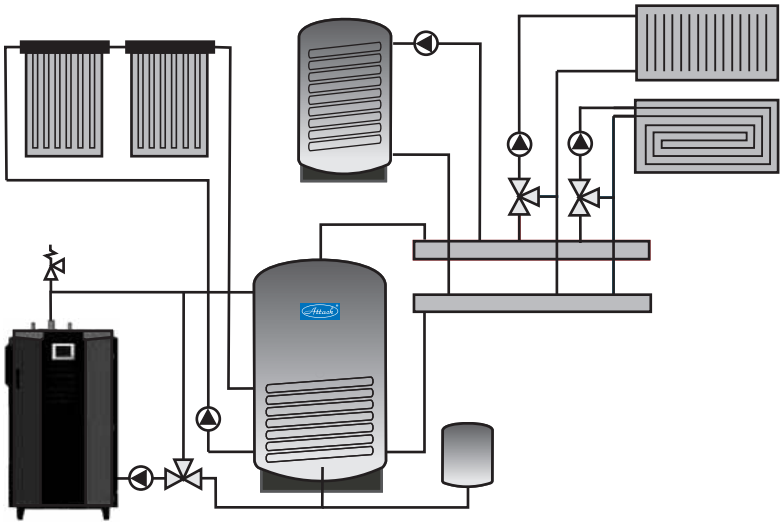

8. ATTACK AS

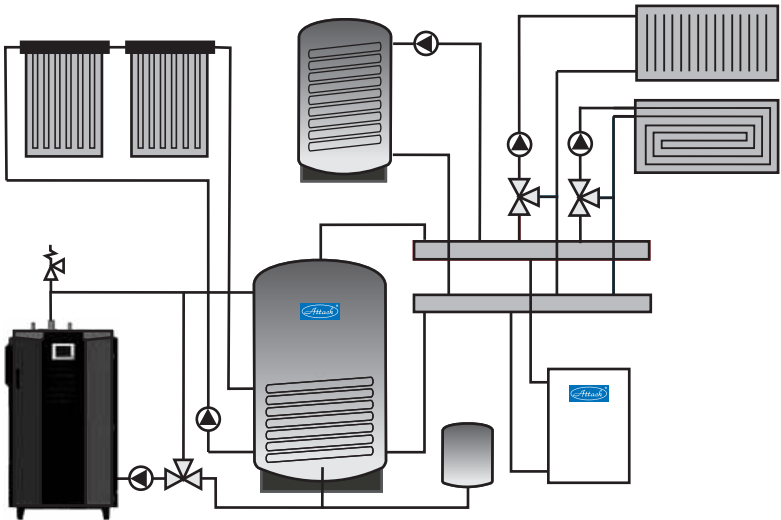

9. ATTACK AK BIVALENT

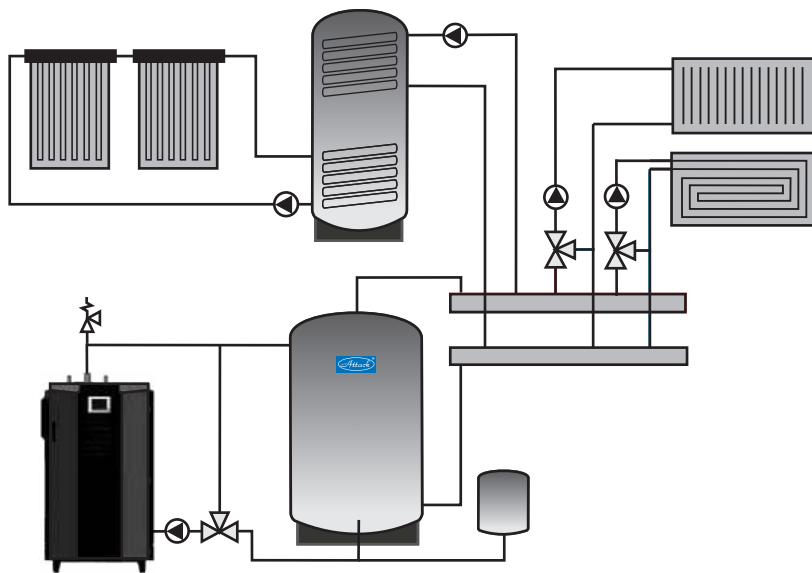

10. ATTACK AK BIVALENT

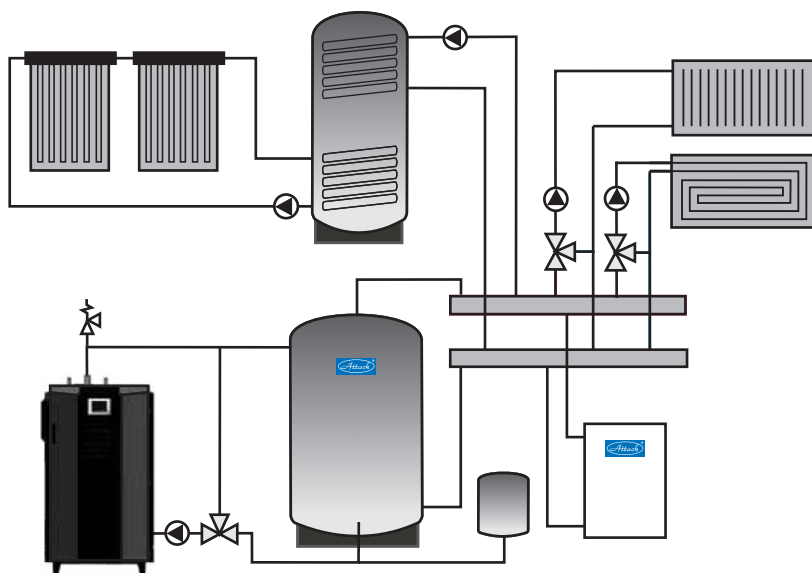

11. ATTACK AK 2x

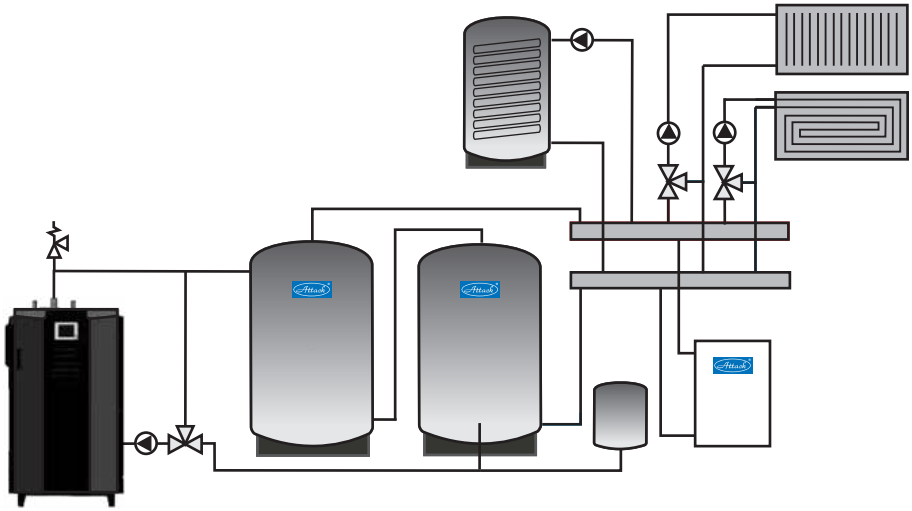

12. ATTACK AK 2x

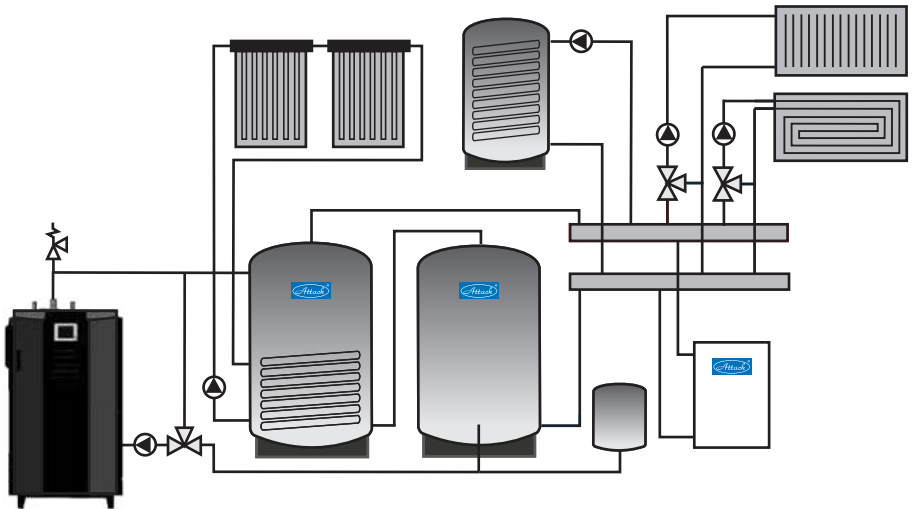

13. ATTACK HR

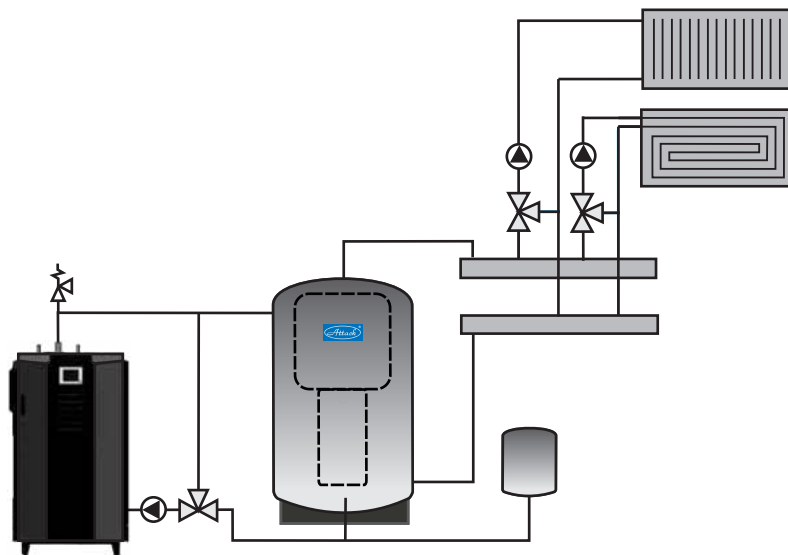

14. ATTACK HR

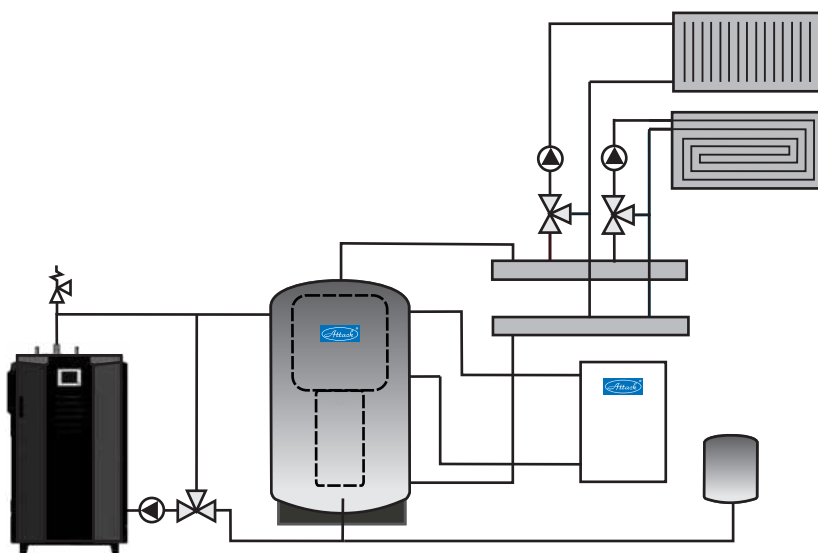

15. ATTACK HRS

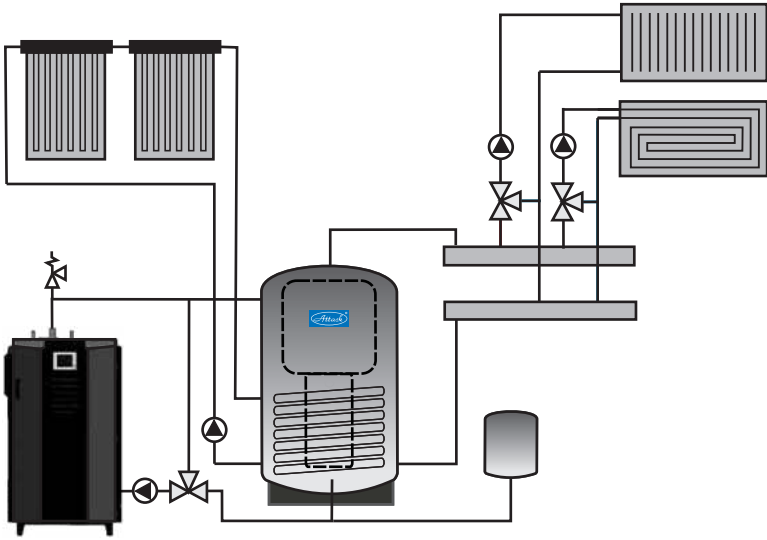

16. ATTACK HRS

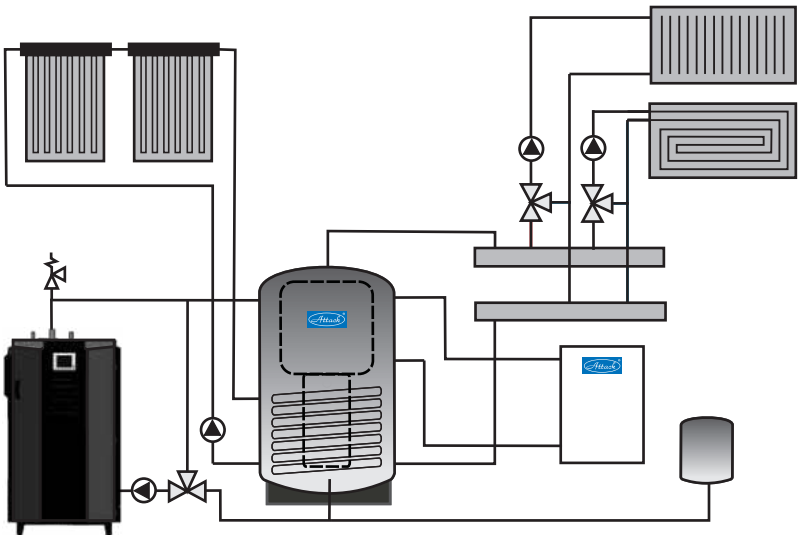

17. ATTACK HRS + ATTACK AK

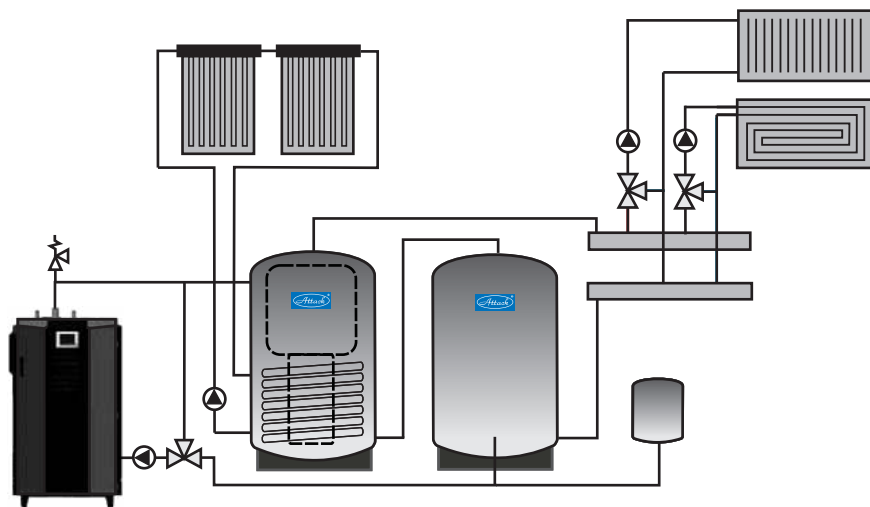

18. ATTACK HRS + ATTACK AK

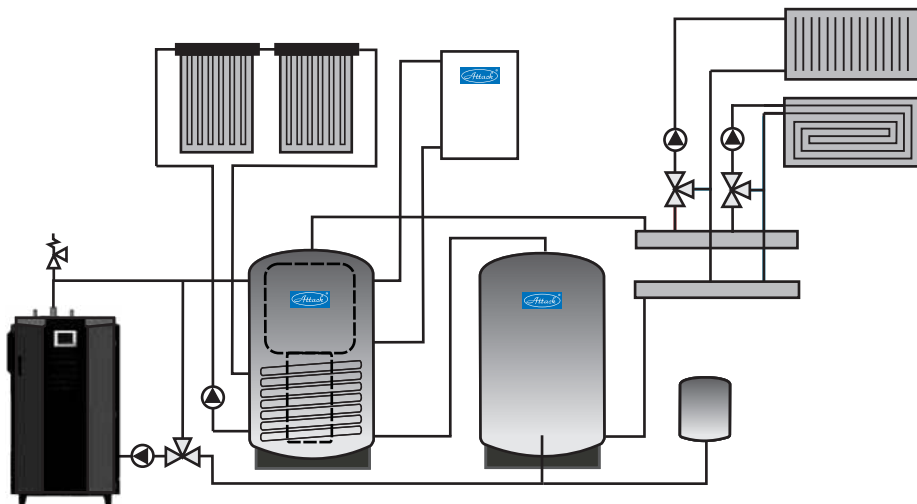

19. ATTACK TUV

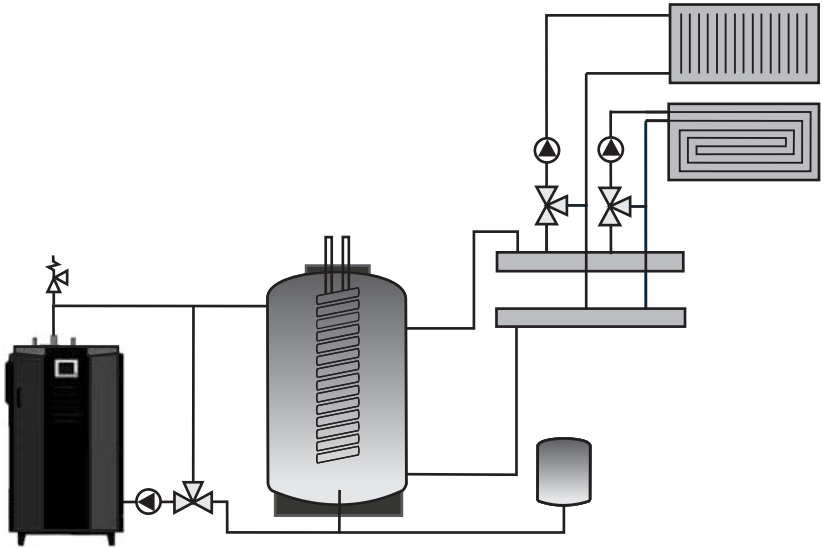

20. ATTACK TUV

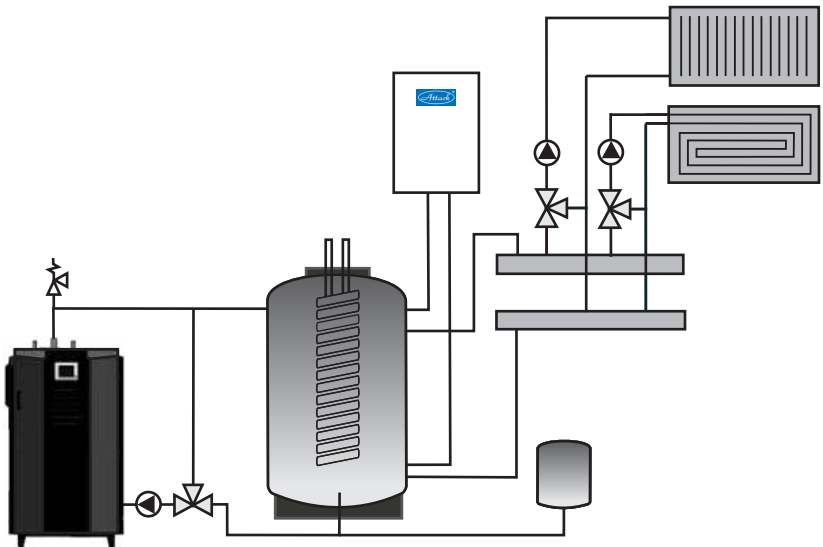

21. ATTACK TUVS

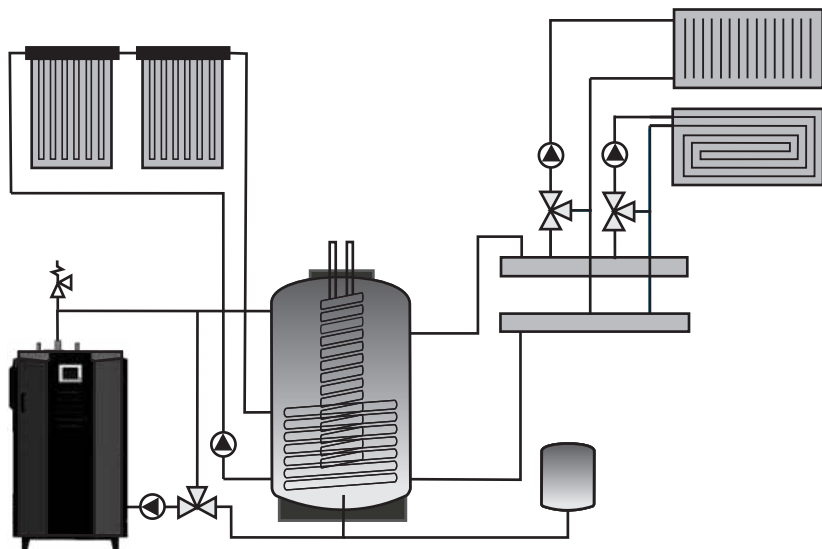

22. ATTACK TUVS

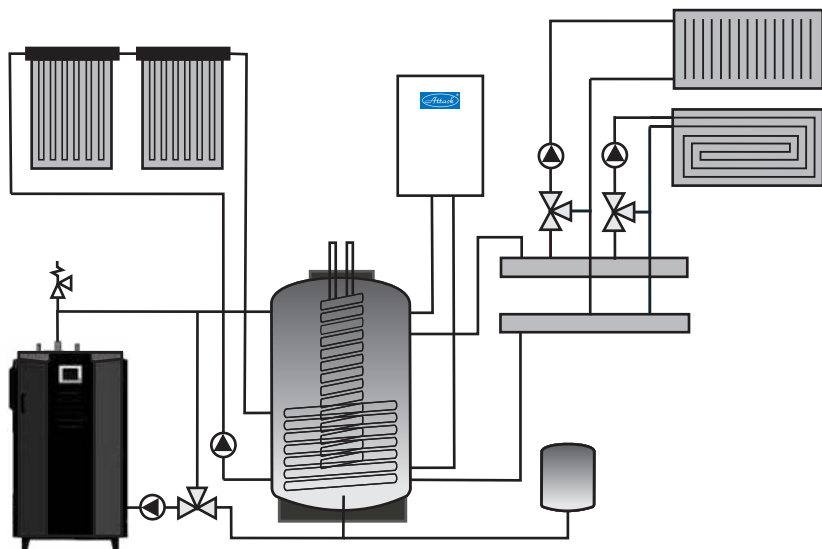

23. ATTACK FD Automat + ATTACK AK

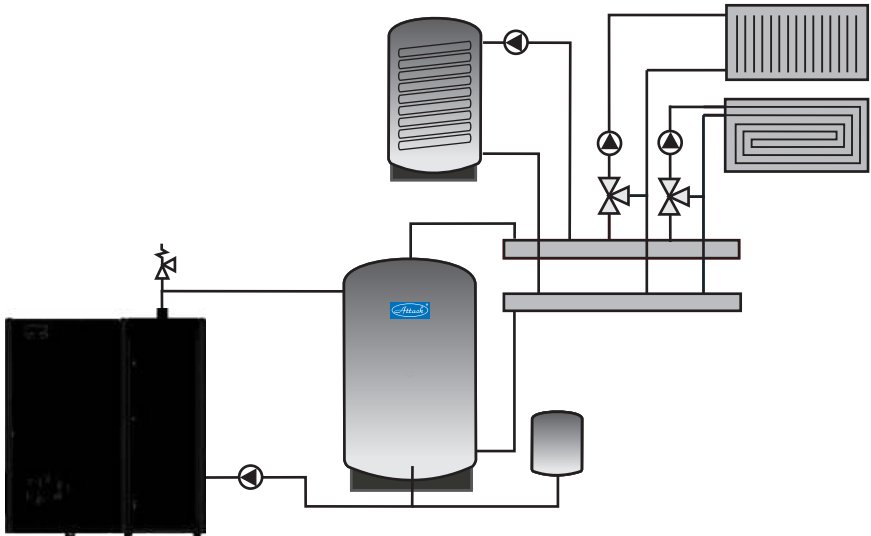

24. ATTACK FD Automat + ATTACK AK

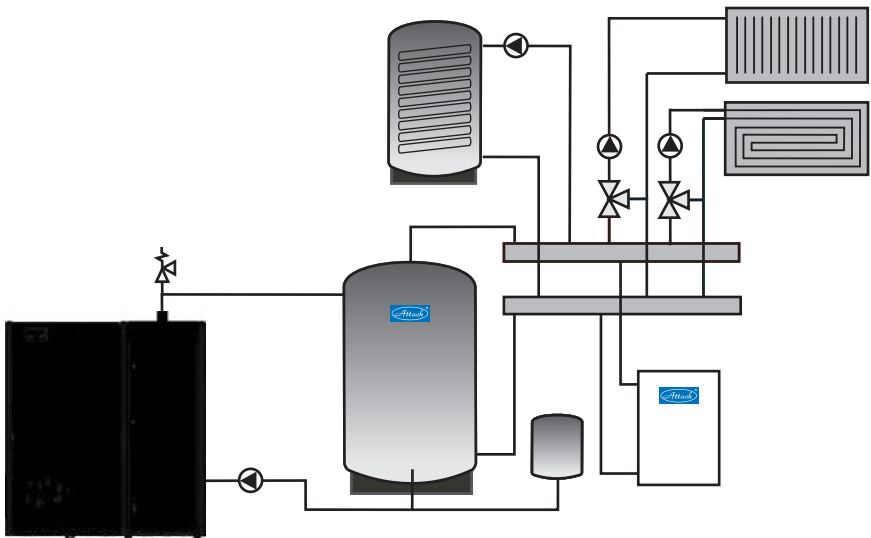

25. ATTACK FD Automat + ATTACK AS

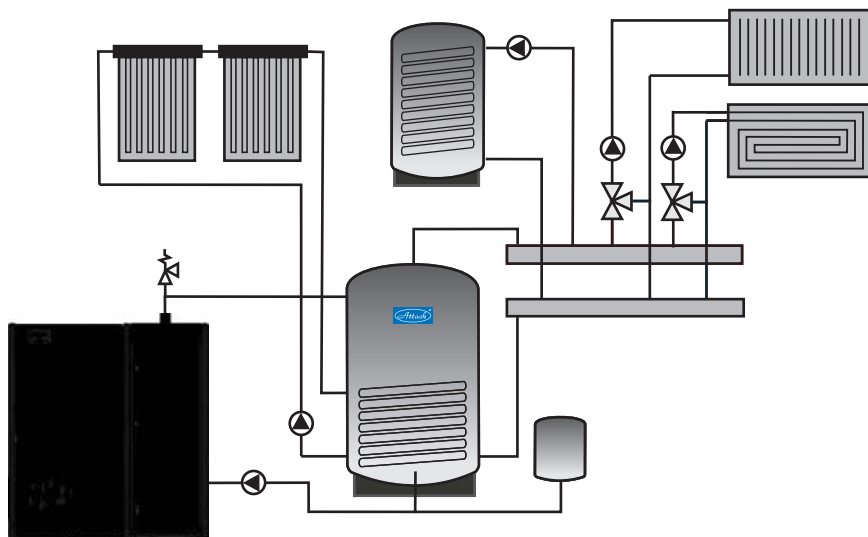

26. ATTACK FD Automat + ATTACK AS

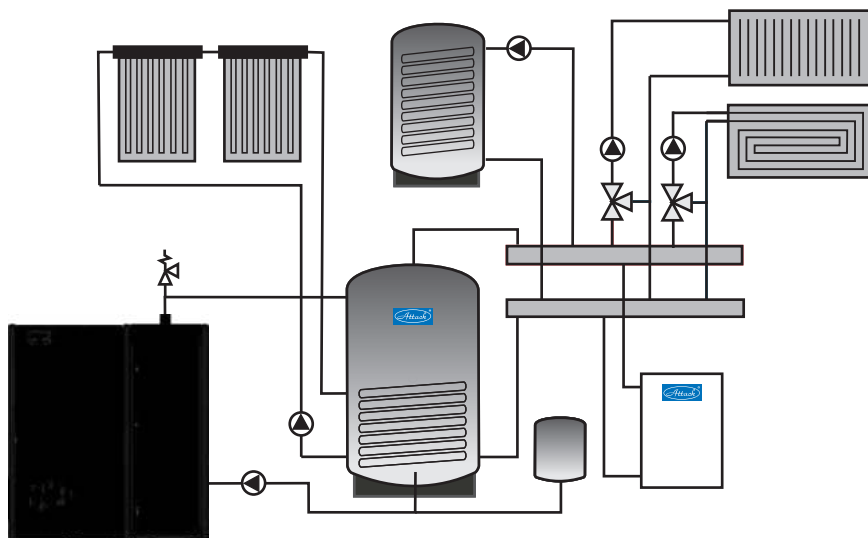

27. ATTACK FD Automat

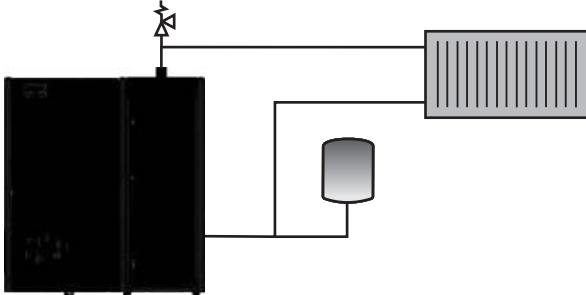

28. ATTACK FD Automat

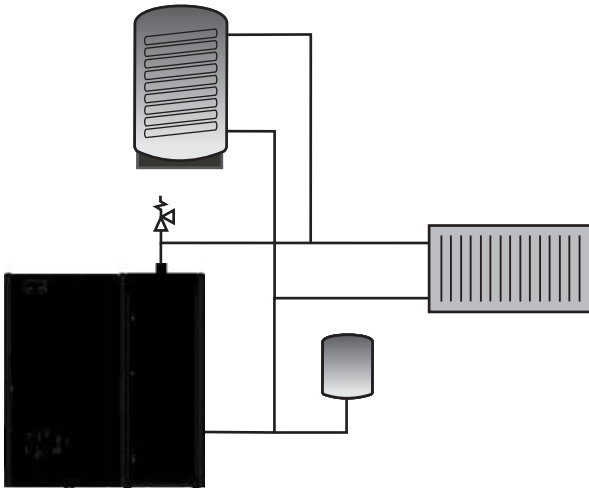

29. ATTACK FD Automat

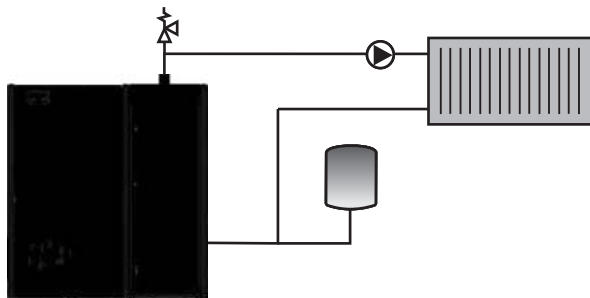

30. ATTACK FD Automat

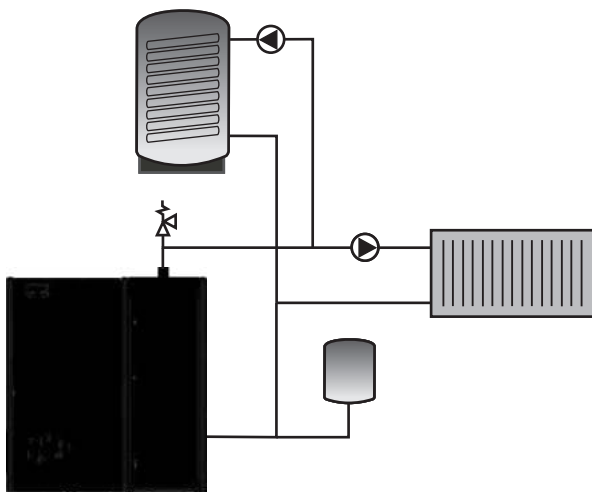

33. ATTACK PELLET 30 AUTOMATIC Plus

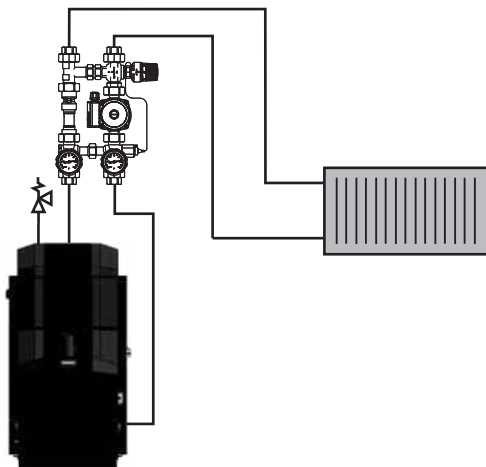

34. ATTACK PELLET 30 AUTOMATIC Plus

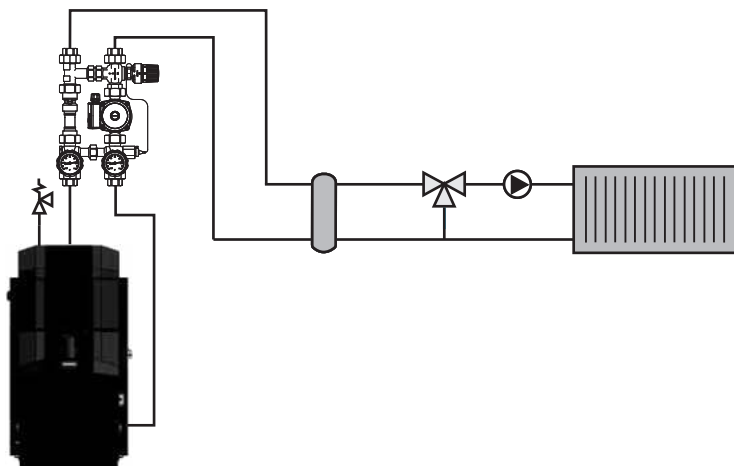

35. ATTACK PELLETT 30 AUTOMATIC Plus

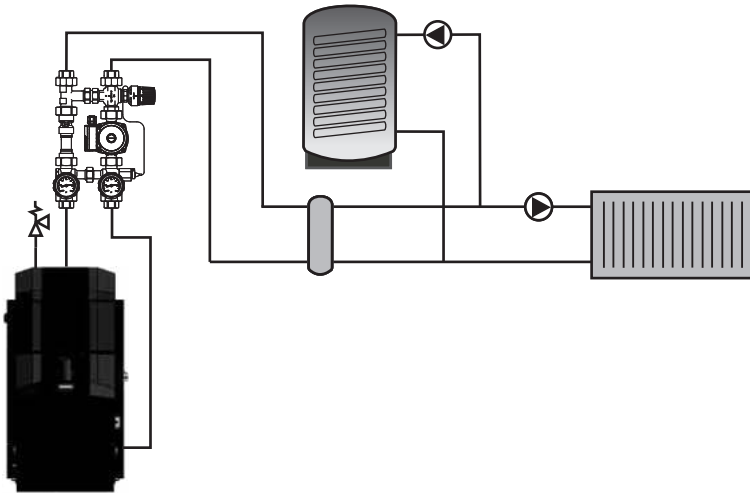

36. ATTACK PELLETT 30 AUTOMATIC Plus

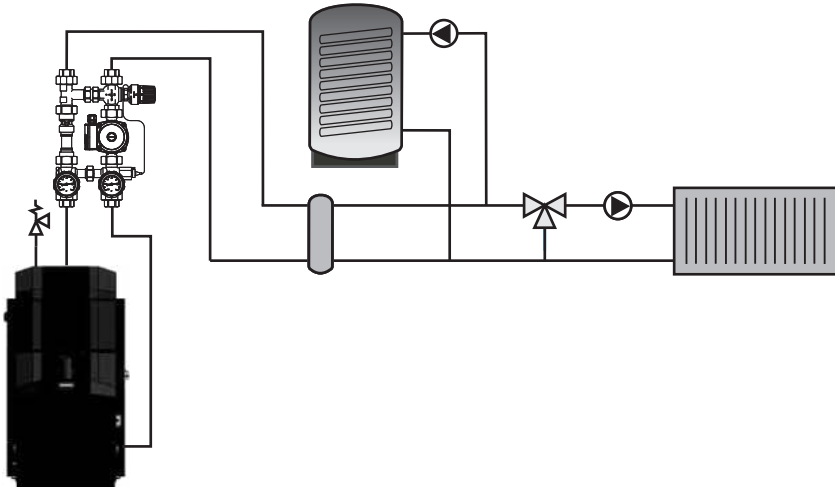

37. ATTACK PELLET 30 AUTOMATIC Plus

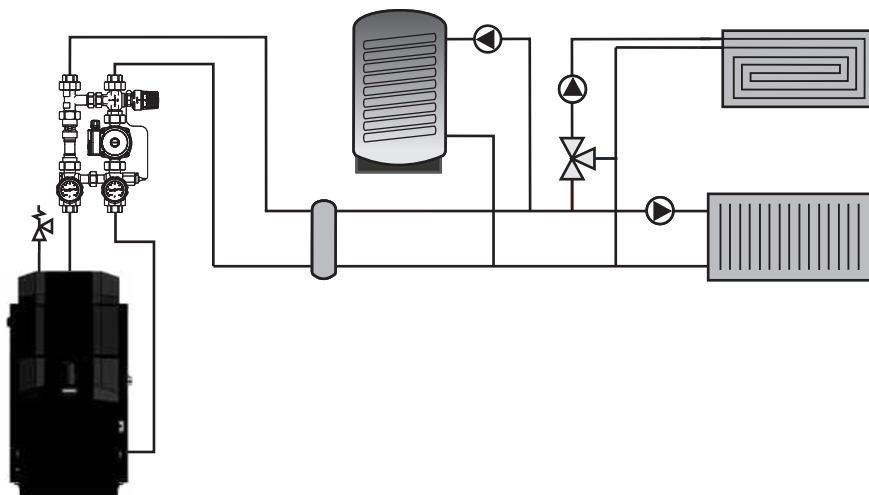

38. ATTACK PELLET 30 AUTOMATIC Plus

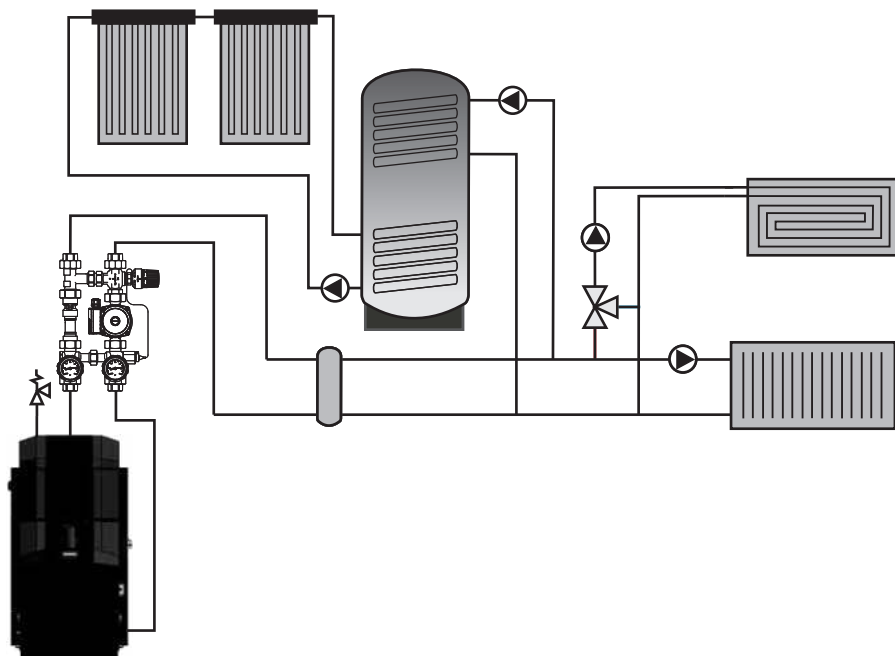



ATTACK, s.r.o.
Dielenská Kružná 5020
038 61 Vrútky
Slovenská republika

Tel: +421 43 4003 101
Fax: +421 43 4003 106
E-mail: kotle@attack.sk
Web: www.attack.sk



Výrobca ATTACK, s.r.o. si vyhradzuje právo technických zmien výrobkov bez predchádzajúceho upozornenia. • ATTACK, s.r.o. producer reserves the right to change technical parameters and dimensions of boilers without previous warning. • Der Hersteller ATTACK, s.r.o. behält sich das Recht der technischen Veränderungen an Produkten ohne eine vorige Warnung. • Изготовитель ATTACK, s.r.o. оставляет за собой право изменения технических параметров и размеров котла без предыдущего предупреждения. • Le producteur ATTACK, s.r.o. réserve le droit des modifications techniques sans l'avertissement précédent. • Productor ATTACK, s.r.o. reserva el derecho de cambios técnicos sin advertencia anterior.

